

LOTUS[®]
Performance, Delivered.[™]



Gas Genset (Recoil)

GL3000X

Made in China/Fabriqué en Chine
Lotus Tool Group (Philippines)
www.lotustoolworks.com



1. SAFETY INFORMATION

EXHAUST FUMES ARE POISONOUS

- Never operate the generator in a closed area or it may cause unconsciousness and death within a short time. Operate the engine in a well-ventilated area.

FUEL IS HIGHLY FLAMMABLE AND POISONOUS

- Always turn off the engine when refueling
- Never refuel while smoking or in the vicinity of an open flame.
- Take care not to spill any fuel on the engine or muffler when refueling.
- If you swallow any fuel, inhale fuel vapor, or allow any to get in your eyes, see your doctor immediately. If any fuel spills on your skin or clothing, immediately wash with soap and water and change your clothes.
- When operating or transporting the machine, be sure it is kept upright. If it tilts, fuel may leak from the carburetor or fuel tank.

ENGINE AND MUFFLER MAY BE HOT

- Place the machine in a place where pedestrians or children are not likely to touch the machine.
- Avoid placing any flammable materials near the exhaust outlet during operation.
- Keep the machine at least 1 m (3 ft) from buildings or other equipment, or the engine may overheat.
- Avoid operating the engine with a dust cover.

ELECTRIC SHOCK PREVENTION

- Never operate the engine in rain or snow.
- Never touch the machine with wet hands otherwise you may get electrical shock.
- Be sure to ground the generator.

NOTE: _____

Use ground lead of sufficient current capacity.

Diameter: 0.12mm (0.005 in)/ampere

EX: 10 Ampere --1.2mm (0.055 in)

CONNECTION NOTES

- Avoid connecting the generator to commercial power outlet.
- Avoid connecting the generator in parallel with any other generator.

BATTERY (On Electric Start Models ONLY)

- No smoking while handling the battery.
- The battery emits flammable hydrogen gas, which can explode if exposed to electric arcing or open flame.
- Keep the area well-ventilated and keep open flames/sparks away when handling the battery

2. CONTROL FUNCTION

OIL WARNING SYSTEM

When the oil level falls below the lower level, the engine stops automatically. Unless you refill with oil, the engine will not start again.

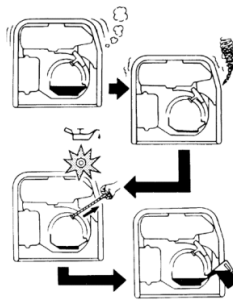

ENGINE SWITCH

The engine switch controls the ignition system.

① "ON"(run)

Ignition circuit is switched on.

The engine can be started.

② "OFF"(stop)

Ignition circuit is switched off.

The engine will not run.

③ "START"

Engine Switch is switched on.

The starter motor starts.



AC CIRCUIT BREAKER SWITCH / NON FUSE BREAKER (N.F.B.)

This AC switch turns off automatically when the load exceeds the generator rated output.

CAUTION: Reduce the load to within specified generator rated output if the Circuit Breaker turns off.

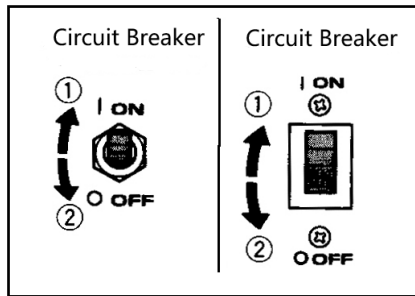

DESCRIPTION

- | | | |
|-------------------------|---------------------|---------------------------------|
| (1) Fuel Tank | (2) Fuel Tank Cap | (3) Fuel Shut Off Valve |
| (4) Air Filter Cover | (5) Spark Plug | (6) Muffler |
| (7) Choke Lever | (8) AC Receptacle | (9) Engine Switch |
| (10) Ground Terminal | (11) Oil Filler Cap | (12) Oil Drain Plug |
| (13) Recoil Starter | (14) Fuel Gauge | (15) Oil Warning Light (option) |
| (16) AC Current Breaker | (17) Voltmeter | |

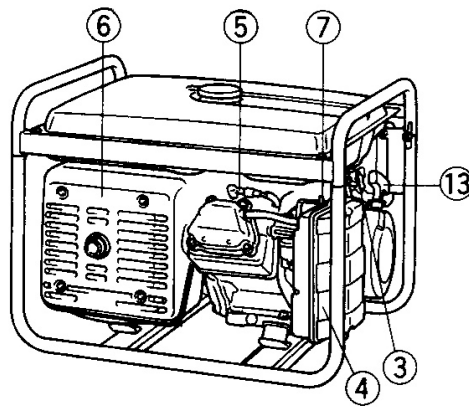
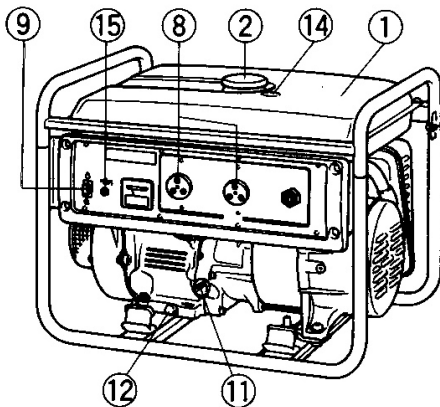

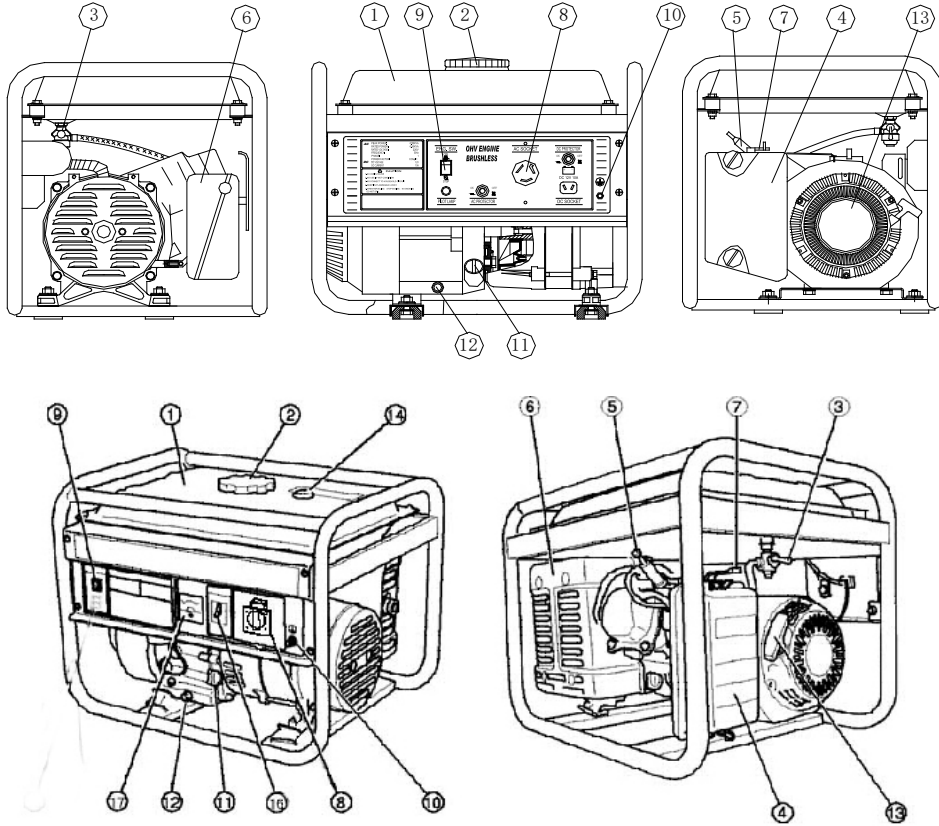

3. BEFORE OPERATION CHECK LIST

NOTE: Before operation checks should be made each time the generator is used.

CHECK ENGINE FUEL

- Check fuel level
- If fuel level is low, refill with unleaded gasoline.
- Be sure to use the fuel filter screen on the fuel filter neck.
- Recommended fuel: Unleaded gasoline.
- Fuel tank capacity:

Model	Full
1.5KW	6L
3.0KW, 3.5KW	17L
6.5KW, 8.5KW, 9KW, 10KW	26L

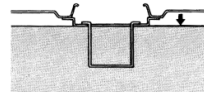
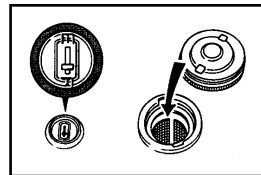

WARNING:

- Do not refill tank while engine is running or hot.
- Close fuel shut off valve before refueling with fuel.
- Be careful not to admit dust, dirt, water or other foreign objects into fuel.
- Wipe off spilt fuel thoroughly before starting engine.
- Keep open flames away.

CHECK ENGINE OIL

Before checking or refilling oil, be sure the generator is put on a stable and level surface with the engine stopped.

- Remove oil filler cap and check the engine oil level.
- If oil level is below the lower level line, refill with suitable oil to upper level line. Do not screw in the oil filler cap when checking oil level.
- Change oil if contaminated.
- Oil capacity

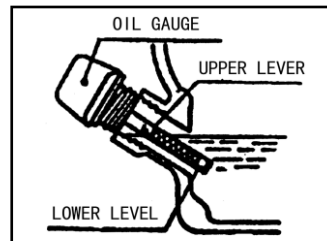

Model	Full
1.5KW	0.5L
3KW, 3.5KW	0.6L
6.5KW, 8.5KW, 9KW, 10KW	1.1L

- Recommended engine oil: Synthetic Motor Oil

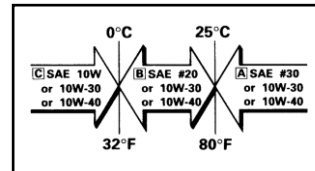

GROUND

Make sure to ground the Generator.

4. OPERATION

NOTE: The Generator has been shipped without engine oil. Fill with oil or it will not start.

STARTING THE ENGINE

NOTE:

- Before starting the engine, do not connect the electric apparatus. Keep circuit breaker in OFF position.

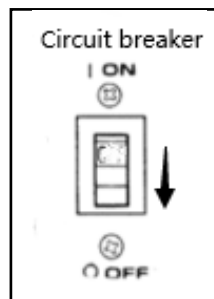
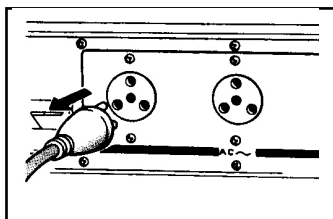

1. Turn the fuel shut off valve to "ON" position.

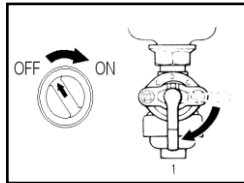

2. Turn the choke lever to the "START" position. Not necessary if the engine is warm.

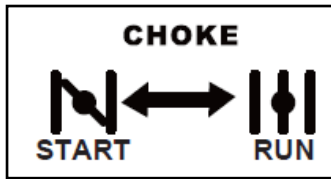

3. Turn the engine switch to "ON" position.



4. [FOR RECOIL START ONLY] Pull the starter handle slowly until resistance is felt. This is the "Compression" point. Return the handle to its original position and pull swiftly. Do not fully pull out the rope. After starting, allow the starter handle to return to its original position while still holding the handle.

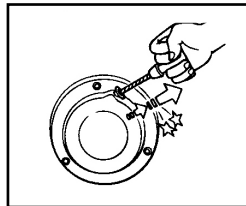

5. Allow engine to warm up for 30s, then turn the choke lever back to the "RUN" position slowly.
6. Allow engine to warm up without load for 2 minutes.

USING ELECTRIC POWER

1. AC APPLICATION (SINGLE VOLTAGE TYPE)

- Check the voltmeter or pilot light for proper voltage.
- Turn off the switch(es) of the electrical appliance(s) before connecting to the generator.
- Insert the plug(s) of the electrical appliance(s) into the receptacle.
- Turn the circuit switch to The "ON" position and turn on the electric apparatus

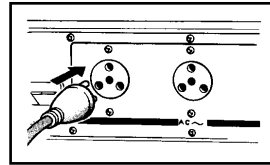

CAUTION:

- Be sure the electric apparatus is turned off before plugging in.
- Be sure the total load is within generator rated output.
- Be sure the socket load current is within socket rated current.
- To take out power from TWIST LOCK receptacle (Optional), insert the plug into receptacle and turn clockwise to lock it..

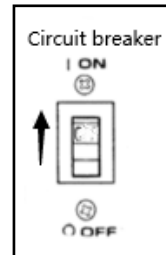

2. AC APPLICATION (DUAL VOLTAGE TYPE)

- Select the voltage using the CIRCUIT BREAKER SELECT SWITCH in accordance with the electrical appliance.
- Operate in the same way as step (a) through step (d) of single voltage type.

NOTE: Voltmeter always indicates the lower voltage whichever the CIRCUIT BREAKER SELECT SWITCH is set to.

3. DC APPLICATION (optional)

This usage is applicable to 12V battery charging only.

- Charging instruction for battery
 - Disconnect the leads for the battery.
 - Make the battery fluid filler cap fully loose.
 - Fill distilled water to the upper limit, if the battery fluid is low level.
 - Measure the specific gravity for the battery fluid by using the hydrometer, and calculate the charging time in according with the table shown on right side.
 - The specific gravity for the fully charged battery shall be within 1.26 to 1.28. It is recommended to confirm every an hour.
- Connect between the DC output socket and the battery terminals using the charging leads. The leads shall be connected making sure of the (+) and (-) polarity.
- The DC circuit protector is to be set to "ON" after confirming the connection, if the protector is in "OFF" position.

3) STOPPING THE ENGINE

- Turn off the power switch of the electric apparatus or unplug the cord from receptacle of the generator.
- Turn the Circuit Breaker to "OFF".
- Turn the engine switch to "OFF".
- Turn the fuel shut off valve lever to "OFF".

4) BATTERY (Optional, Electric starting system ONLY)

1. REPLENISHING THE BATTERY FLUID

- Check the fluid level. The level should be between the upper and lower level marks.
- Add only distilled water if necessary.

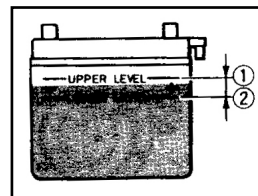

2. BATTERY STORAGE

Remove the battery and charge it. Store it in a dry place and recharge it once a month. Do not store the battery in an excessively warm or cold place.

3. RECOMMENDED BATTERY

- Recommended battery: 12V/7A•h & 12V/17A•h

NOTE: _____

- Clamp the red wire to the positive (+) terminal and the black wire to the negative (-) terminal of the battery. Do not reverse these positions.
- Be sure the battery is installed on the battery mount tray securely

NOTE: In order to increase the Life of your generator it is advantageous to maintain a minimum load of approximately one third the rated output.

5. PERIODIC MAINTENANCE

MAINTENANCE CHART

Regular maintenance is most important for the best performance and safe operation.

Item	Remarks	Pre-operation Check (Daily)	Initial 1 Month or 20 Hr	Every 3 Months or 50 Hr	Every 6 Months or 100 Hr	Every 12 Months or 300 Hr
Spark Plug	Check condition adjust gap and clean. Replace if necessary.			•		
Engine Oil	Check oil level	•				
	Replace		•		•	
Air Filter	Clean. Replace if necessary.			•		
Fuel Filter	Clean fuel shut off valve filter. Replace if necessary				•	
Valve Clearance	Check and adjust when engine is cold.					•
Fuel Line	Check fuel hose for crack or damage. Replace if necessary.	•				
Exhaust System	Check for leakage. Re-tighten or replace gasket if necessary	•				
	Check muffler screen. Clean / replace if necessary.				•	
Carburetor	Check choke operation	•				
Cooling System	Check fan damage.					•
Starting System	Check recoil starter operation	•				
Decarbonization	More frequently if necessary.					•
Fittings/ Fasteners	Check all fittings and fasteners correct if necessary.				•	

2) ENGINE OIL REPLACEMENT

1. Place the machine on a level surface and warm up the engine for 5 minutes. Then stop the engine.
2. Remove the oil filler cap
3. Place an oil pan under the engine. Remove the oil drain plug so that the oil can be completely drained.
4. Check the oil drain plug, gasket, oil filler cap and O-ring. If damaged replace.
5. Re-install the oil drain plug.
6. Add engine oil to the upper level.

• Recommended engine oil: Synthetic Oil (see page 6)

CAUTION: Be sure no foreign material enters the crankcase.

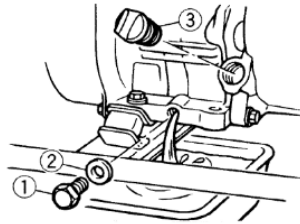

3) AIR FILTER

Maintaining an air cleaner in proper condition is very important. Dirt induced through improperly installed, improperly serviced, or inadequate elements damages and wears out engines. Keep the element always clean.

1. Take out the air cleaner, clean it well in kerosene and dry it.
2. After wetting the element with clean engine oil, squeeze it tight by hand.
3. Place the element in the case and install it securely.

CAUTION: The engine should never run without the element; excessive piston and/or cylinder wear may result.

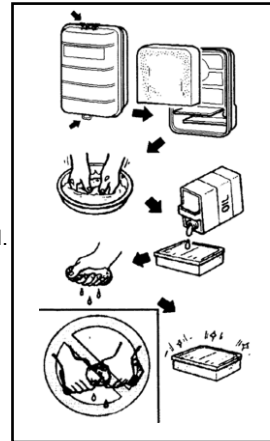

Standard electrode color: Tan Color

Standard Spark Plug: F7TC

Spark Plug Gap: 0.7-0.8 mm (0.028-0.031 in)

4) CLEANING AND ADJUSTING SPARK PLUG

5) FUEL SHUT OFF VALVE

1. Stop the engine.
2. Turn the fuel shut off valve lever to "OFF".
3. Clean with solvent.
4. Wipe off.
5. Check the gasket. Replace it if damaged.

! WARNING BE sure the fuel shut off valve cup is tightened securely.

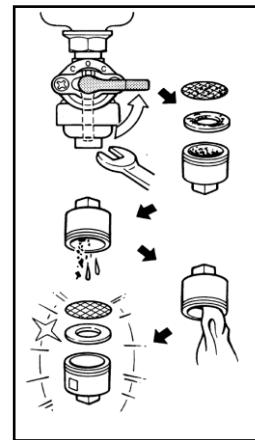
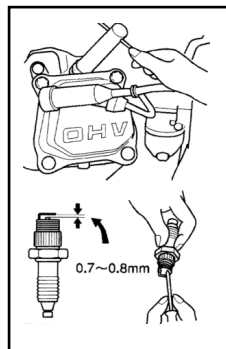

6) FUEL TANK FILTER

- ① Clean with solvent.
- ② Wipe off.
- ③ Fuel tank filter.

! WARNING Be sure the tank cap is tightened securely.

7) MUFFLER SCREEN

! WARNING

- The engine and muffler will be very hot after the engine has been run.
- Avoid touching the engine and muffler while they are still hot with any part of your body or clothing during inspection or repair.

1. Remove the muffler protector and muffler screen.
 2. Clean the carbon deposits out of the muffler screen using a wire brush.
 3. Check the muffler screen. Replace it if damaged.
 4. Install the muffler screen and muffler protector.
- ① Muffler protector ② Muffler screen

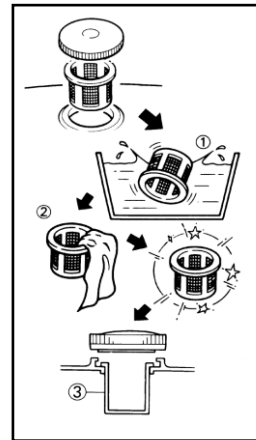
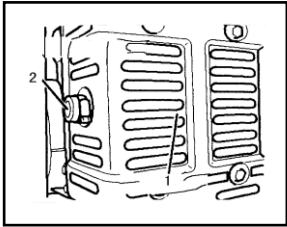

6. TROUBLE SHOOTING

ENGINE TROUBLE SHOOTING

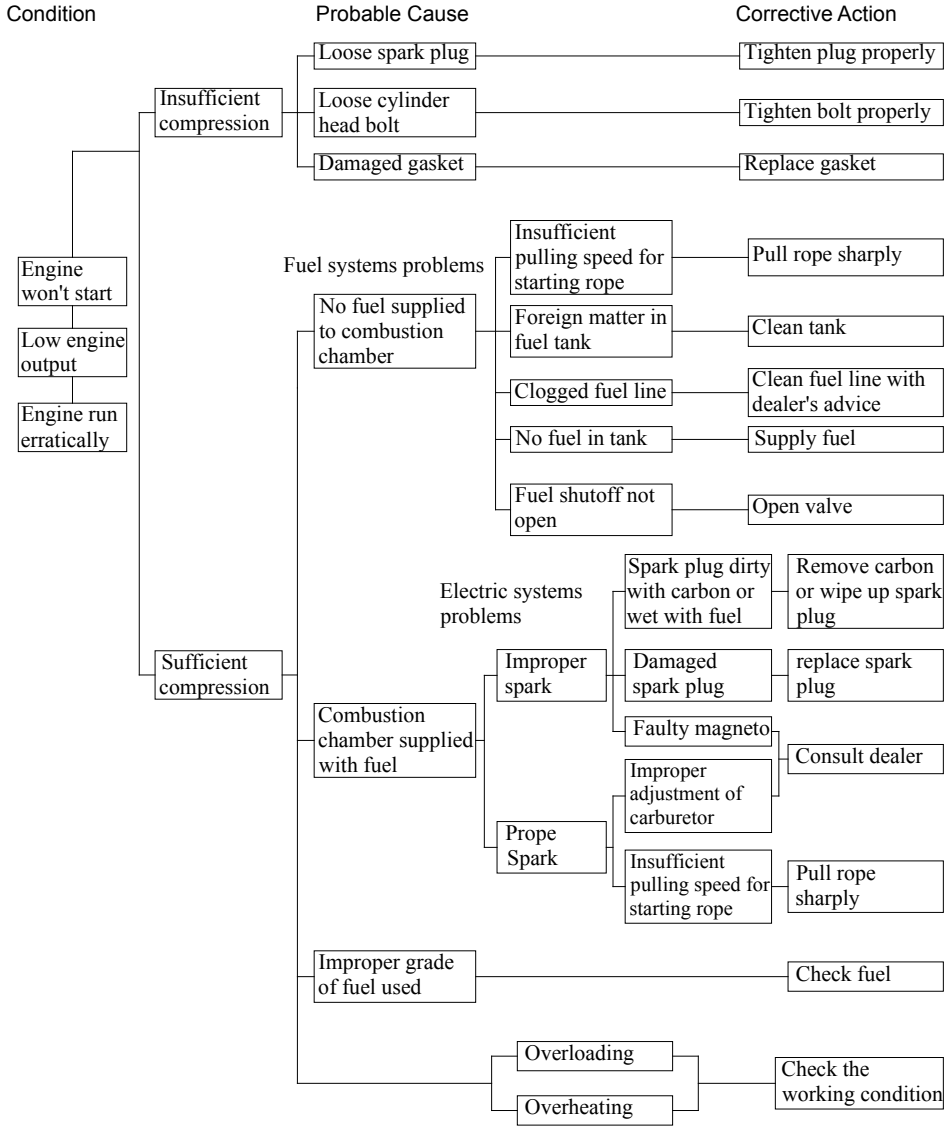

GENERATOR TROUBLE SHOOTING

Condition	Probable Cause	Corrective Action
Indicator light ON No AC output	Tripped circuit breaker	Reset
	Poor Connection or faulty lead	Check and Repair
	Broken Receptacle	Check and Repair
	Faulty circuit breaker	
Indicator light OFF No AC output	Generator problem	Consult Dealer
Indicator light OFF No DC output	Tripped circuit breaker	
	Poor Connection or faulty DC power cord	Check and Repair
	Generator problem	Consult Dealer
Output power available abnormality exists	Engine RPM set too high or low	No load for 60Hz Set 3780rpm No load for 50Hz Set 3150rpm
	Loose component	Locate and tighten
	Internal generator problem	Consult Dealer

Engine Won't Start

1. Fuel Systems: No fuel supplied to combustion chamber.
 - No fuel in tank....Supply fuel.
 - Clogged fuel line....Clean fuel line.
 - Foreign matter in fuel shut off valve .Clean fuel shut off valve.
 - Clogged carburetor....Clean carburetor.
2. Engine Oil System::Insufficient
 - Oil level is low....Add engine oil.
- 3.Electrical systems: Poor spark
 - Spark plug dirty with carbon or wet....Remove carbon or wipe spark plug dry.
 - Faulty ignition system....Consult dealer.
4. Compression Insufficient
 - Worn out piston and cylinder....Consult dealer.
 - Loose cylinder head nuts....Tighten nuts properly.
 - Damaged gasket....Replace gasket.

7. STORAGE

Long-term storage of your machine will require some preventive procedures to guard against deterioration.

1) DRAIN THE FUEL

1. Drain the fuel tank, fuel shut off valve and carburetor float bowl.
2. Add a cup of SAE 10W30 or 20W40 motor oil.
3. Shake the tank.
4. Drain off the excess oil.

2) ENGINE

5. Pour in about one tablespoon of SAE 10W30 or 20W40 motor oil.
6. Use the recoil starter to turn the engine over several times (with ignition off).
7. Pull the recoil starter until you feel compression.
8. Stop pulling.
9. Clean exterior of the generator and apply a rust inhibitor.
10. Store the generator in a dry, well-ventilated place.
11. The generator must remain in an upright position.

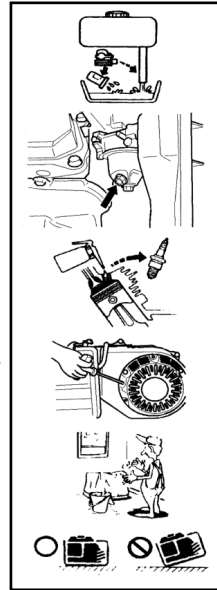

8. SPECIFICATION

Items	GL1500X	GL3000X	GL3500EX	GL6500EX	GL8500EX	GL10000EX
Voltage/Frequency	220V/60HZ	220V/60HZ	220V/60HZ	220V/60HZ	220V/60HZ	220V/60HZ
Rated Power (Real)	1.2KW	2.2KW	2.8KW	5.5KW	7.0KW	8.5KW
Max Power (Real)	1.5KW	3.0KW	3.5KW	6.5KW	8.5KW	10.0KW
Fuel Tank Capacity	6L	17L	17L	26L	26L	26L
Continuous Run Time	8H	13H	11H	10H	8.5H	7H
GW/NW	25/24kgs	42/40kgs	44/42kgs	81/79kgs	87/85kgs	89/87kgs
Packing Dimension(mm)	475*365*375	630*455*510	630*455*510	710*555*565	710*555*565	710*555*565
Wiring	copper	copper	copper	copper	copper	copper
Type	4-Stroke, Overhead Valve, Single Cylinder, Forced Air cooling					
Igniting Mode	Transisterized Magneto Ignition					
Starting System	Recoil	Recoil	Recoil or Electrical	Recoil or Electrical	Recoil or Electrical	Recoil or Electrical
Engine output	3.5HP	6.5HP	6.5HP	13HP	15HP	17HP
Borex Stoke (mmxmm)	56x40	68x54	68x54	88x64	92x68	92x69
Displacement(cm ³)	98	196	196	389	420	458
Oil capacity	0.5L	0.6L	0.6L	1.1L	1.1L	1.1L
Fuel type	Regular Gasoline					